



**Semi Instantaneous Water Heater  
Steam-to-Water Mini-Pack™ System  
DWSW Electric  
Operating and Maintenance Manual**



*Designed and Manufactured in  
Accordance with  
ASME Code Section VIII, Div 1*



# Table of Contents

---

## Page

2	Operating and Installation Instruction
3	The Mini-Pack Name Plate and Model Number
5	The Parts of the Boiler <ul style="list-style-type: none"><li>How it works</li></ul>
6	Receiving your Mini-Pack <ul style="list-style-type: none"><li>General Installation Instruction</li></ul>
9	Installation Diagram <ul style="list-style-type: none"><li>Single-wall</li><li>Double-wall</li></ul>
11	Before Start Up <ul style="list-style-type: none"><li>Start Up instructions</li><li>Shut down instructions</li><li>Safety features</li></ul>
14	Trouble-shooting Guide
16	Maintenance Instruction <ul style="list-style-type: none"><li>Removing the tube bundle</li><li>Mini-pack component weights</li><li>Gasket installation</li><li>Tube bundle and bonnet installation</li><li>Preventive maintenance</li><li>Replacement parts</li><li>Material Safety Data Sheet</li><li>Contact Us</li></ul>

## Warranty

# Operating and Installation Instructions

## (Electric)

---

Congratulations on your purchase of a new Ace “Mini-Pack”. In this book, we have included installation and maintenance instructions that, if followed, will provide you with many years of service from your new unit. Also included are instruction manuals for each of the controls furnished with the heater. Please read them carefully. They should be helpful in both the installation and service of this unit. Keep these instructions with the Mini-Pack for future reference.

The Ace Mini-Pack is of rugged construction, yet of simple design. The heater uses steam (or water) from a boiler to heat domestic water. The Mini-Pack’s temperature control system enables it to control the heated water within  $\pm 4^{\circ}\text{F}$  of the selected temperature during normal operating conditions. This close control is accomplished by placing the temperature control element directly in the constant flow path of the hot domestic water outlet. The integral circulator constantly recirculates a portion of the heated water to the cold-water inlet, making the total volume of the heater a tempering chamber. This also eliminates any overheated water pockets caused by control valve lag when the hot water demand is suddenly reduced.

The Mini-Pack features total rust free construction with austenitic stainless and copper for all domestic water contact surfaces, providing a high quality, low maintenance and an extremely cost effective domestic water heating package.

The tubes are rolled and flared into a stainless steel tube sheet. All Ace Mini-Packs can be serviced completely without breaking the domestic water lines or disturbing the heater foundation.

Each Mini-Pack is constructed and stamped in accordance with Section VIII, Div. 1, of the ASME Code, which is stamped on the Mini-Pack rating plate.

Experience in the field has proven that the Ace Mini-Pack, if properly applied and maintained, will give many years of efficient, dependable and economical service.

# The Mini-Pack™ Nameplate and Model Number

## The Mini-Pack Nameplate

The following illustration is an accurate depiction of the nameplate found on the mini-pack.

- A. NB or serial number
- B. Shell pressure
- C. Shell temperature
- D. Tube pressure
- E. Tube temperature
- F. Min. Atmospheric Pressure
- G. Atmospheric temperature
- H. Serial number
- I. Year built
- J. Model number
- K. Capacity
- L. Square feet
- M. Job number

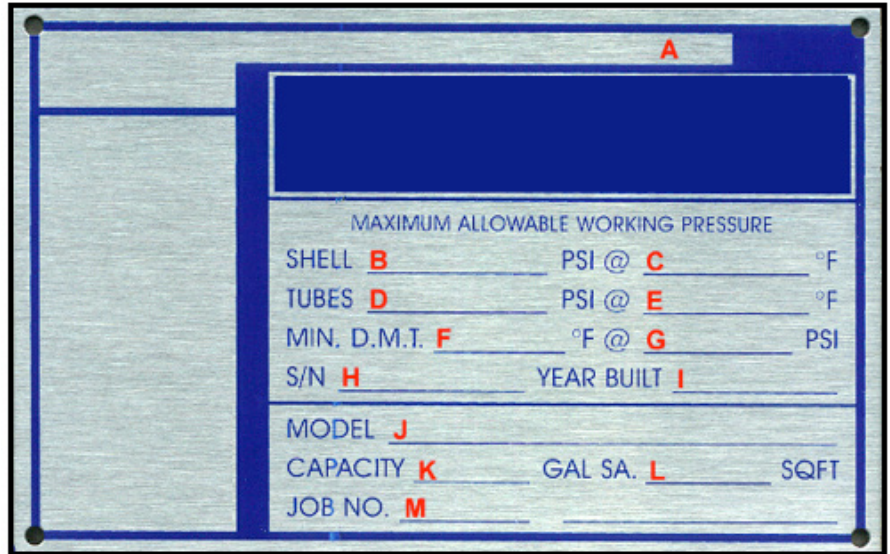

**SI H 08 L SW S A 1.25**

## The Mini-Pack Model Number

- SI = Model (SI = Semi-Instantaneous)
- V = Type (H = Horizontal, V = Vertical)
- 08 = Shell diameter in inches
- L = Blank (standard), L (Long), XL (Extra long) bundle length
- SW = Tube bundle type (SW = Single wall, DW = Double wall)
- W = Heating medium (S = Steam, W = Water)
- A = Control valve (A = Air Operated, P = Pilot operated, E = Electric)
- 1.25 = Valve size

# The Mini-Pack™ Nameplate and Model Number

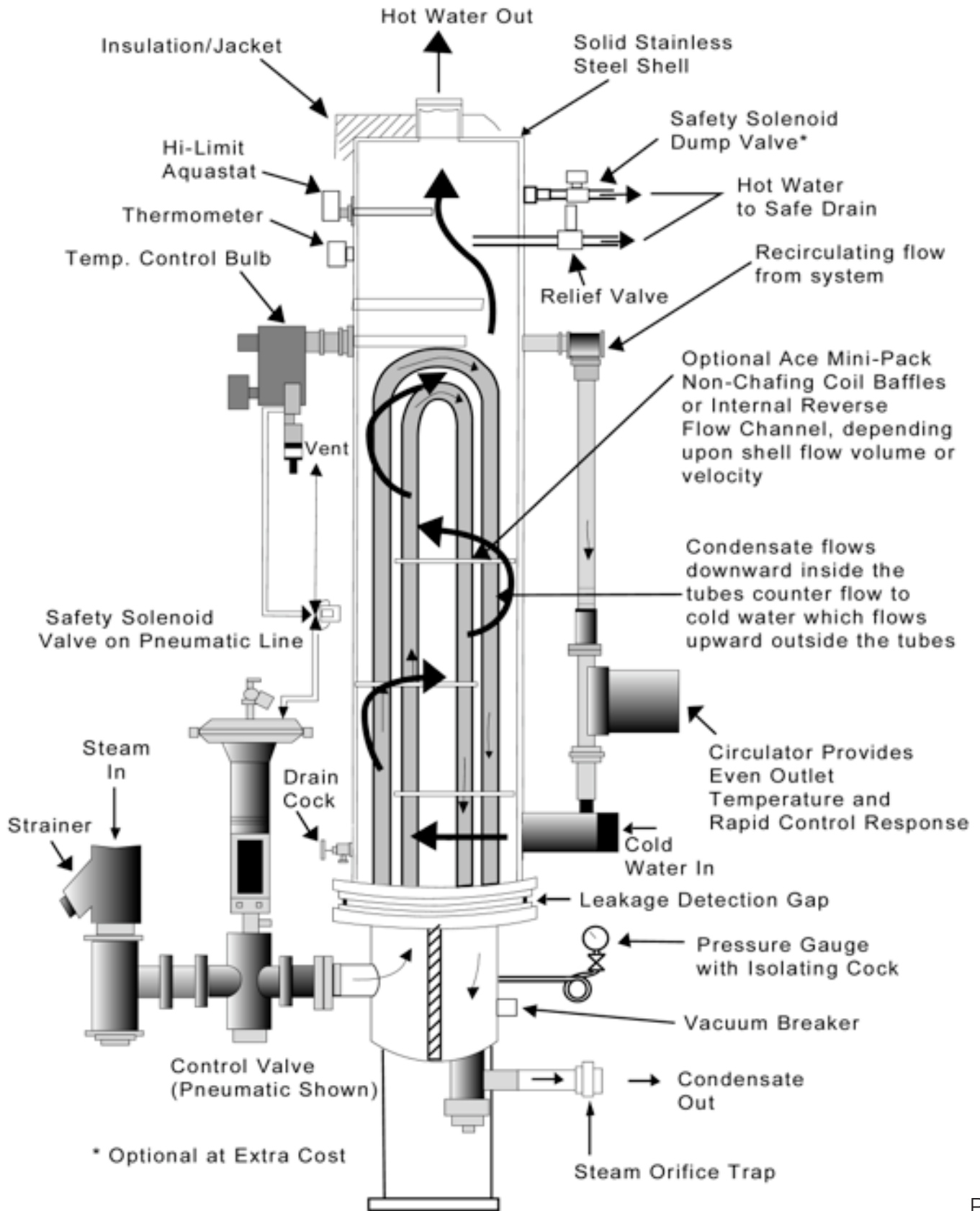

# How it Works!

---

The Mini-Pack is designed to heat domestic hot water using existing plant steam or hot boiler water, and regulates the domestic hot water outlet temperature to a close tolerance of  $\pm 4^{\circ}\text{F}$  from the set point. The advantage of this system is it replaces the need for large hot water storage tanks and is much more efficient.

As there is a demand for domestic hot water, the temperature control bulb will sense the drop in water temperature. The temperature bulb sends a signal to the control valve to open and allow steam or hot boiler water into the heat exchanger tube bundle. As the steam or hot boiler water passes through the tubes, the domestic water in the shell is rapidly heated. Above the tube bundle, a minimal water volume storage area is provided to give the controls sufficient time to react to the changes in water temperature.

The circulator constantly rotates the water in the shell, eliminating any hot spots, which could cause false readings at the control valve.

As the steam or boiler water passes through the tubes, it is sub-cooled by the incoming domestic cold water. As the demand for hot water fluctuates, the control valve will respond accordingly, quickly reacting to keep the water temperature within  $\pm 4^{\circ}\text{F}$ . In the event the water temperature in the Mini-Pack continues to climb, the high limit control will trip, cutting the electrical current to the solenoid valve on the control panel, which in turn relieves the air signal to the control valve and causes it to close.

On units equipped with a double safety solenoid valve, the system is designed to dump the overheated water through the solenoid dump valve when the high limit is tripped.

# Receiving Your Mini-Pack™

---

**Check Equipment Received.** Inspect the unit for any shipping damage. Make sure you have received all loose parts, as listed on the “Bill of Lading”. Larger strainers, usually 2 ½” and above, are shipped loose. Note any damages or shortages on the bill of lading prior to signing it. **If the Mini-Pack is received damaged or missing parts, it is your responsibility to notify the shipping company and file a freight claim.** Ace Heaters cannot send replacement parts for freight damaged or missing equipment as warranty items. Permission to return goods must be received from the factory prior to shipping. Goods returned without a Returned Goods Authorization number will not be accepted. Purchased parts are subject to replacement only under the manufacturer’s warranty. The warranty does not include the cost of labor, removal, or installation of the warranted part.

## General Installation Instructions

**NOTE:** *All electrical and piping installation should only be accomplished by qualified personnel following all applicable local, and state codes required for their installation.*

**Code Requirements:** It is very important that your installation comply with all federal, state and local codes as well as meet good industry practices as shown in publications issued by ASME, UL, ASHRAE, ABMA, etc.

**Placement:** The Mini-Pack can be mounted two ways; either vertically on its base or horizontally, using its mounting brackets for wall, ceiling or rack mounting. The Mini-Pack should be installed on a solid foundation, preferably a concrete pad or with heavy duty bolting if mounted on a wall or ceiling. Provide adequate clearance for normal inspection and maintenance purposes and allow tube pull clearance from the base of the unit. A minimum clearance of 24” is recommended from all accessories for ease of maintenance. Make sure the Mini-Pack is level, from side to side and front to back. Use metal shims if necessary.

**Piping:** Control valve hot water supply line shall be flushed prior to installation or with the shut-off valve closed to isolate the Mini-Pack from the system. This is imperative to avoid any damage to the valve seat during startup procedures AND TO AVOID WARRANTY ISSUES. All piping to and from the Mini-Pack must be provided with adequate supports and expansion compensation so that pipe stresses are not transmitted to the Mini-Pack. The relief valve and the double-safety solenoid valve, if supplied, should be piped to a safe drain.

**Stud Nuts:** During shipment, the bonnet and shell flange nuts may loosen and should be re-tightened before start-up. Tighten these nuts to the torques specified later in this manual. After the unit has been in operation for a few days and periodically thereafter, check and retighten. Note: Bolting is independent on the bonnet and shell-side flanges through the use of a threaded tube sheet flange(s). Therefore, stud bolt nuts must be re-tightened on both sides. See Figure 1.1 for single-wall bolting arrangement and Figure 1.2 for double-wall bolting arrangement.

# Receiving Your Mini-Pack™

**Torque's:** The following are recommended bolt torque requirements

MP Size	Bolt Size * (Y)	Gasket Thickness**	Compressed Thickness (X)	Min Torque (T)	Max Torque*** (T)
4"	1/2"	1/4"	0.018"	45 ft.lb	60 ft.lb
5"	1/2"	1/4"	0.018"	45 ft.lb	60 ft.lb
6"	1/2"	3/8"	0.025"	45 ft.lb	60 ft.lb
8"	1/2"	3/8"	0.025"	45 ft.lb	60 ft.lb
10"	5/8"	3/8"	0.025"	90 ft.lb	120 ft.lb
12"	5/8"	3/8"	0.025"	90 ft.lb	120 ft.lb
16"	5/8"	1/2"	0.035"	90 ft.lb	120 ft.lb

**Notes:**

- \* Spray each stud bolt and nut generously with penetrating oil before re-torque.
- \*\* Gasket thickness before compression. All partition gaskets are 1/8" in width before compression. All gaskets expand twice their width after compression.
- \*\*\* These are recommended torque values. Stud bolts must not be stressed above 60% of their yield strength.

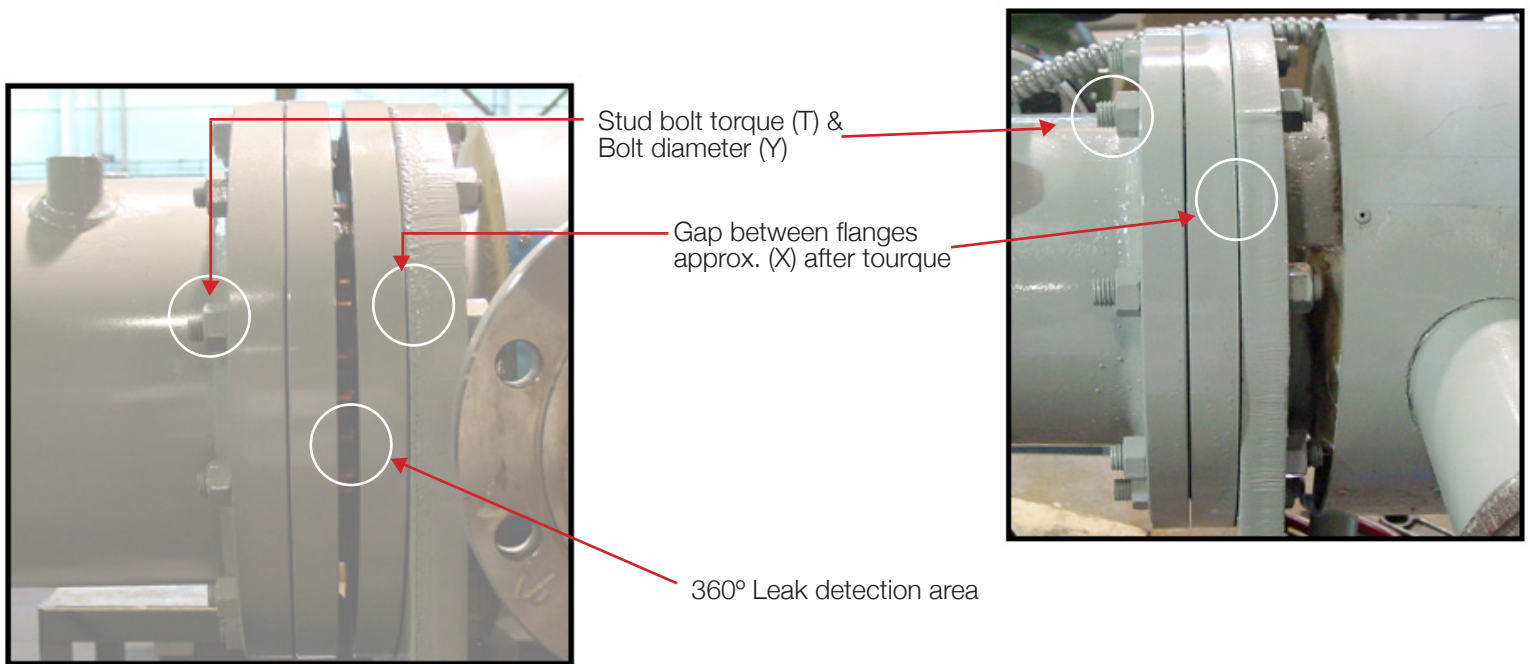

Figure 1.1 Shell flange to bonnet flange joint  
DW Tube Bundle



# Receiving Your Mini-Pack™

---

**Water Connections:** See Typical piping diagram (Page 10 and 11).

**Relief Valve:** The relief valve discharge must be piped to a floor drain to eliminate the potential of scalding burns. The drain line must be the same size as the relief valve outlet and have a downward slope to insure proper drainage. The drain line termination should be visible to see discharge. Check the relief valve nameplate. The unit's operating pressure cannot exceed that listed on the relief valve.

**Electrical:** The Mini-Pack is wired for 120volts 60hz 1phase 3 amps, unless otherwise noted on the heater nameplate. Verify the electrical supply using a voltmeter. The voltage tie-in leads are indicated on the wiring diagram. For your safety, turn off electrical power supply at the service entrance panel before making any electrical connections. This unit contains sensitive control components and should be protected by a suitable commercial grade surge protection device and electrically grounded. The Mini-Pack must be installed in accordance with the National Electric Code and all state and local codes.

**Water Treatment:** Proper water treatment plays an important role in protecting the life of your investment. Ace Heaters recommends consulting a water treatment specialist prior to start-up for recommendations on water treatment. The Mini-Pack uses boiler steam or hot water as its heating medium. On hot water systems, boiler makeup water continuously introduces contaminants; scale forming solids, corrosive minerals and oxygen, which can cause corrosion or scale formation inside the Mini-Pack tube bundle. Whenever appreciable amounts of raw makeup water are continuously added to your system, we recommend that the problem be brought to the attention of a qualified water consultant. Proper treatment will insure longer product life and reduced maintenance.

**Control Valve Air Supply Pressure:** The pneumatic controller used on the Mini-Pack requires a reliable compressed air supply. The air supply to the control valve shall be 30 PSI. Optimum supply pressure to the temperature controller is at least 35 PSI.

**Double Safety Solenoid Valve (optional):** If so equipped, the solenoid valve discharge must be piped to a floor drain. The drain line must be the same size as the solenoid valve outlet and have a downward slope to insure proper drainage. The drain line termination should be visible to see discharge.

# Installation Diagram

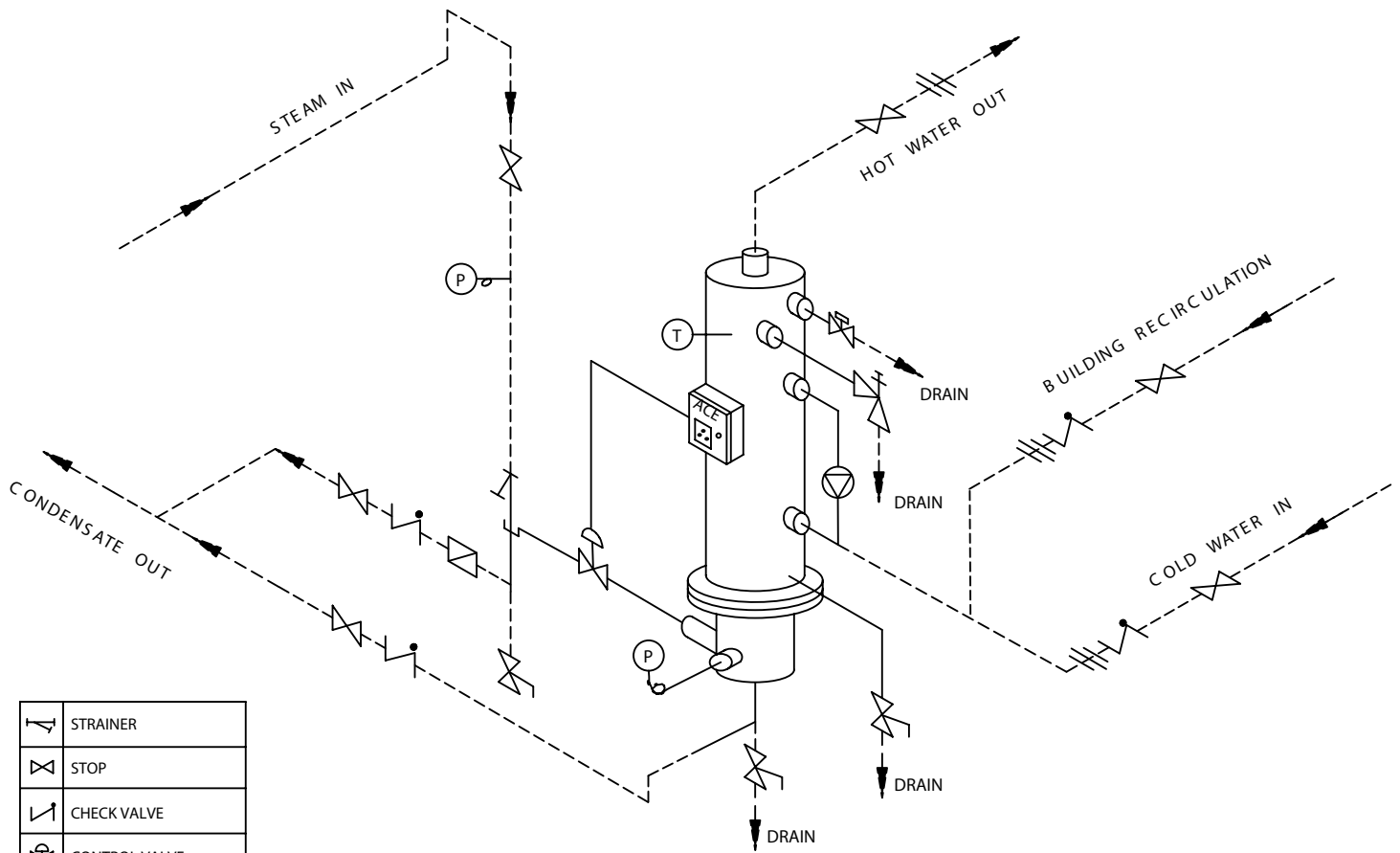

	STRAINER
	STOP
	CHECK VALVE
	CONTROL VALVE
	RELIEF VALVE
	DRAIN VALVE
	UNION
	UNION ORIFICE
	TEMP. GAUGE
	PRESSURE GAUGE
	INTERNAL RECIRCULATOR
	OVER-TEMP SOLENOID OPTION
	AUX. TRAP OPTION

-----  
FIELD PIPING  
BY OTHERS

**Single Unit / Steam-to-Water**

# Installation Diagram

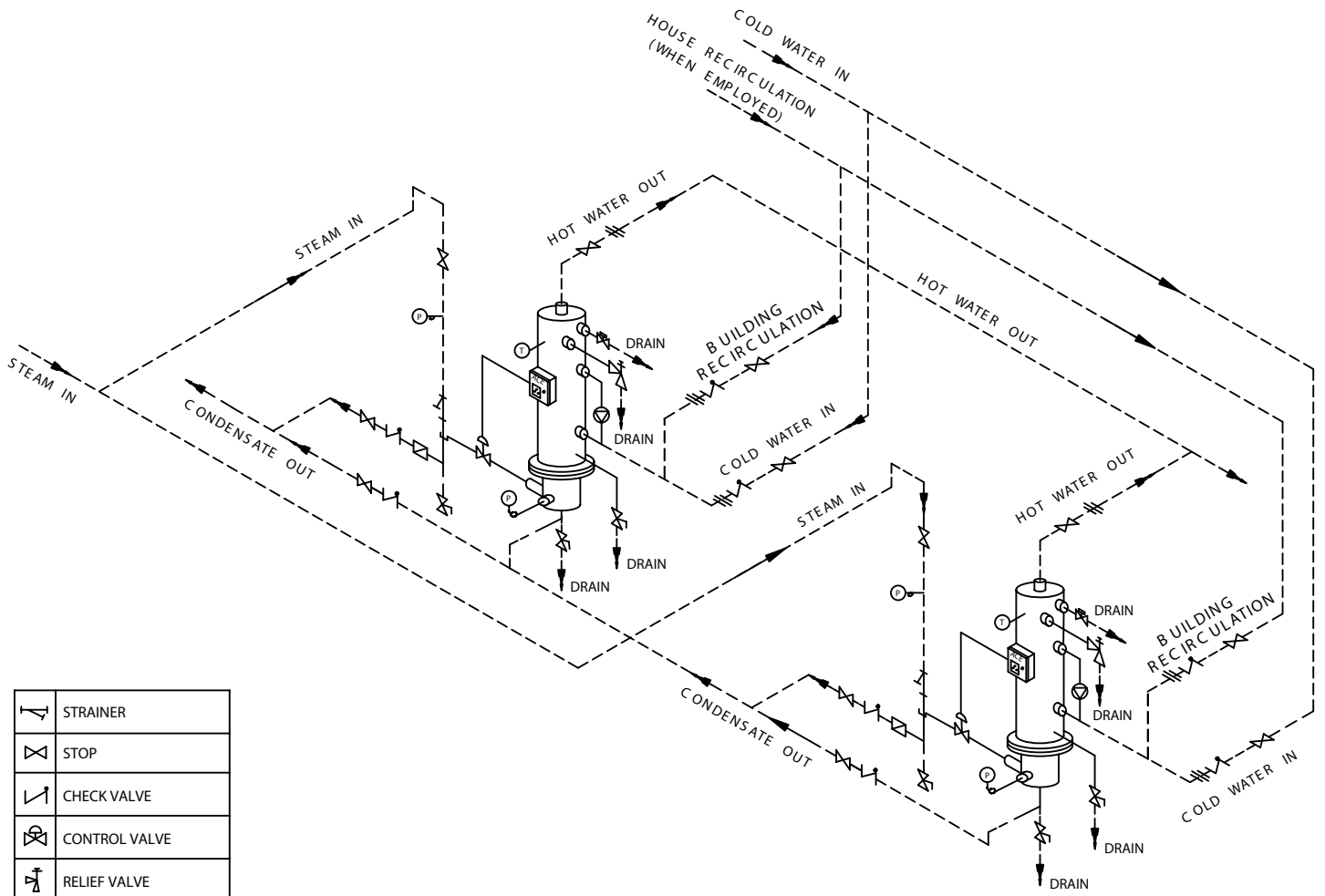

	STRAINER
	STOP
	CHECK VALVE
	CONTROL VALVE
	RELIEF VALVE
	DRAIN VALVE
	UNION
	UNION ORIFICE
	TEMP. GAUGE
	PRESSURE GAUGE
	INTERNAL RECIRCULATOR
	OVER-TEMP SOLENOID OPTION
	AUX. TRAP OPTION

-----  
FIELD PIPING  
BY OTHERS

# Installation Diagram

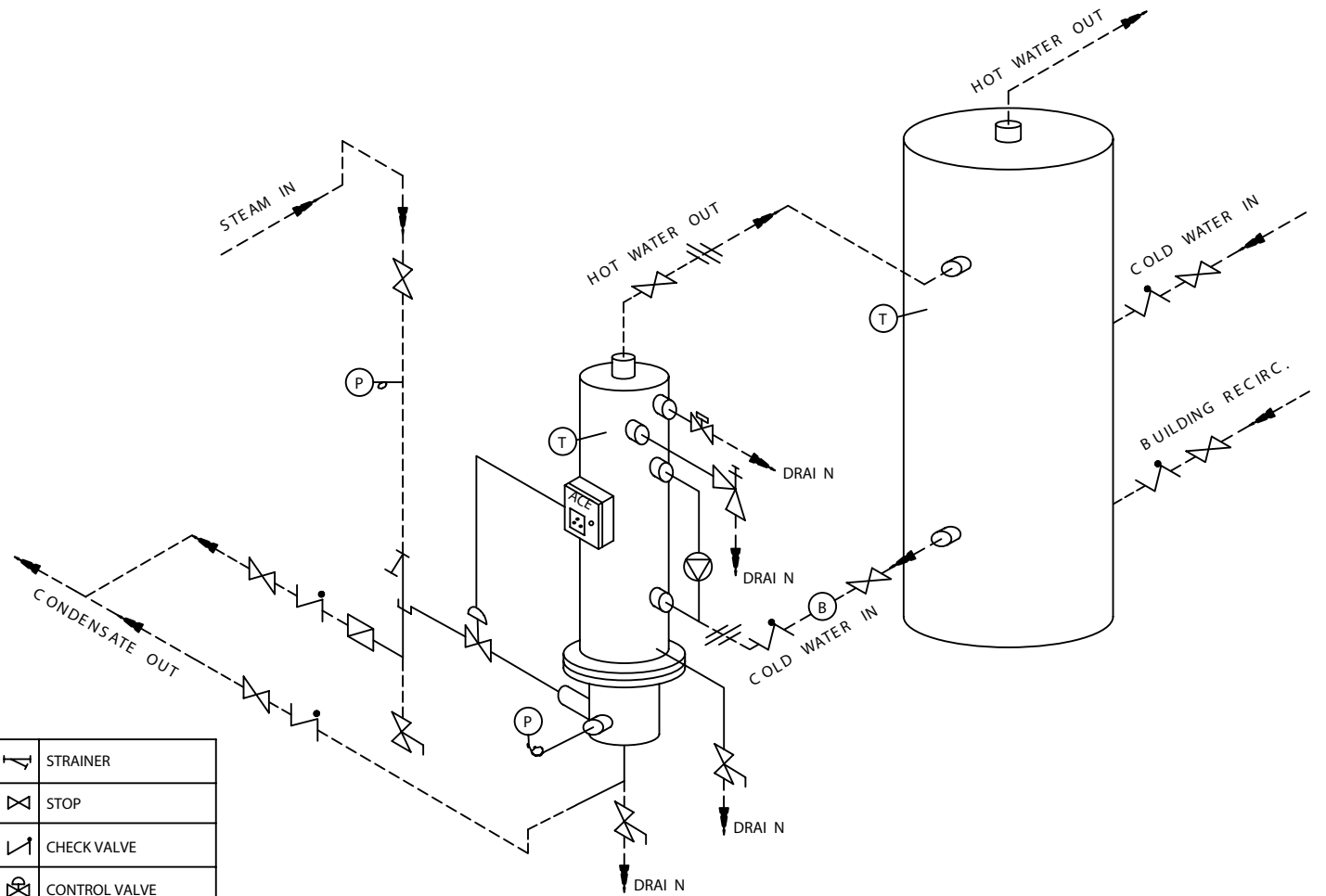

	STRAINER
	STOP
	CHECK VALVE
	CONTROL VALVE
	RELIEF VALVE
	DRAIN VALVE
	UNION
	UNION ORIFICE
	TEMP. GAUGE
	PRESSURE GAUGE
	INTERNAL RECIRCULATOR
	OVER-TEMP SOLENOID OPTION
	AUX. TRAP OPTION
	TANK RECIRCULATOR

-----  
FIELD PIPING  
BY OTHERS

**Steam-to-Water with Tank**

# Before Start-Up

---

1. Verify the Mini-Pack is installed in accordance with the appropriate installation diagram located on page 10 and 11.
2. The condensate outlet union has been factory installed with an orifice plate. Do not remove this orifice, as it acts as a simple steam trap, unless it is substituted with an appropriately sized steam trap.
3. The steam supply to the control valve must be installed with a blow down valve on the strainer and drip leg with trap. This will keep condensate away from the valve.
4. Install a steam pressure gauge within close proximity of the steam inlet side of the control valve.
5. The condensate line must be piped and drained by gravity without lifts, to a vented receiver. Failure to do so will void the warranty.
6. Verify 120/60/1 voltage supply to the control panel according to the wiring diagram. Verify the electrical supply using a voltmeter. The unit should be protected by suitable commercial grade surge protection equipment for the unit's sensitive control components.
7. **Caution:** The toggle switch on the control panel must be in the "off" position prior to connection to the power source. Failure to do so may damage the safety solenoid if so equipped.

## Start-Up Instructions

1. It is assumed that installation is complete and that all connections have been made, including: electrical, steam, domestic water, vents, drains and safety valve discharge lines. Prior to start-up inspect the strainer for any dirt, scale, welding particles or debris that may have accumulated during construction. Make sure the General Installation procedure has been followed (See Page 7).
2. Make sure the power switch is in the "off" position.
3. Close the shut-off valve on the bonnet side (heating medium side).
4. Slowly introduce domestic water to the unit by opening the shut-off valves at the inlet and outlet of the shell. This will allow water to circulate in the shell. Open the relief valve when filling to purge the trapped air from the unit.
5. Plant steam is used as the heating medium and is controlled by an electric control valve, which in turn receives its signal from the temperature sensor. The electrical supply should already be connected to the control panel. Refer to step six in the 'Before Start Up' section if this still needs to be completed.
6. Turn on the system by turning the control panel switch to the "on" position (The manual steam supply valve should be closed at this time). The green light should come on. At the same time, the temperature sensor will send an electrical signal to the controller. With the temperature measured value (PV) being lower than the set point value (SV), the controller will send a signal to the control valve to open. Make sure the circulator pump is running. (Please refer to the pump instruction manual for details.)

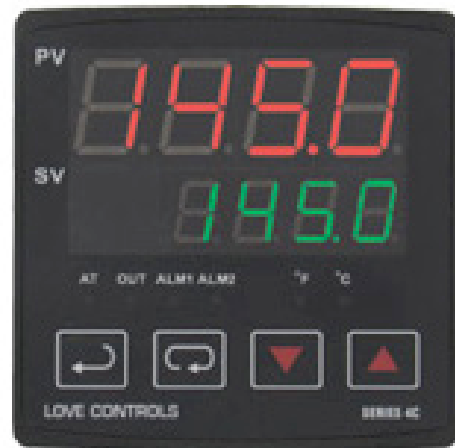

Figure 2.0  
Love Controller

# Before Start-Up

---

7. If the SV is not already set to the required temperature for the outlet on the domestic water you may modify it now while in the Home Display. Use the arrow keys to change the value of the SV parameter then press the **Enter** key to save the change.
8. Turn on a number of hot water fixtures to establish a steady 50% load if possible, with at least a flow of 8 to 10 GPM for the initial startup. Make sure these stay on and there is not an additional load applied elsewhere during initial startup.
9. Manually open the main steam shut-off valve upstream of the control valve and SLOWLY allow steam to pass through the control valve. Continue until the shut-off valve is 100% open.
10. The Mini-Pack will now function automatically, reacting according to demand fluctuations and will stabilize once limits are met.
11. Once stabilized, turn off the hot water fixtures one at a time and watch the temperature gauge on the unit. There should only be slight temperature fluctuations. With no hot water fixtures on, the temperature gauge should remain stable. Watch the temperature for 5 minutes to verify the steam valve has closed. If the temperature slowly creeps up, the valve has a leaking steam and may have debris on the seat or derivative time value may need adjustment. Adjusting this value means. *See the Programming Instructions for Trouble Shooting.*
12. With the system warm, check the operation of the high limit safety control. Do this by adjusting the SV 20°F below the present value. Check to see the red temperature light turns on and engages the control valve to fully close. *Caution:* Very hot water may splash as it is discharged; take the necessary precautions to avoid contact. Make sure the relief valve and dual safety solenoid is piped to drain. Return the temperature dial to the desired set point.
13. Observe the entire system over a period of variable loads to determine if any calibration is necessary on the Love controller.
14. After start-up, inspect the strainer for any dirt, scale, welding particles or debris that may have accumulated and remove as necessary; any debris can damage the valve seat or obstruct it from full shut-off, resulting in possible over-temp conditions and/or scalding.
15. Check the flange bolt section for leaks. Tighten only enough to stop leakage. Never tighten more than necessary. Excessive tightening will shorten the life of the gasket and stretch the studs. *See Page 8 for proper torque values.*

# Shut Down/Trouble Shooting

---

## Shut Down Instructions

1. De-energize all electrical power to the Mini-Pack.
2. Close the main upstream steam shut-off valve to the Mini-Pack.
3. Close domestic water inlet and outlet shut-off valves.
4. Allow the unit to cool down. (Approximately 24 hours).

## Safety Features

1. The electric steam control valve is designed to fail safe (closed) in the event of a power failure.
2. The built in capacitor stores an electrical charge in case of a power failure. If a power failure occurs, the stored electrical charge will force the actuator to fully close against the seat of the valve.
3. The relief valve is designed to relieve the pressure in the Mini-Pack in the event the pressure gets too high.
4. The double safety solenoid (Optional feature, figure 3) is designed to dump the hot domestic water from the shell in the event that the water temperature exceeds the set point on the high limit control. This should be piped to a safe drain per local and state codes.

## Trouble Shooting

### 1. Water temperature too high:

1. Check the setting of the SV. Verify it is the outlet temperature required. The control valve should be modulating on the open side when the SV is below the PV and the control valve should be modulating closed when the SV is higher than the PC. If this is not the case the temperature sensor may be inoperable. Confirm by following the next series of steps.
2. Confirm steam supply pressure to the control valve conforms to that specified in the List of Materials (*See List of Materials enclosed*).
3. Confirm that the domestic water inlet and outlet valves are 100% open.
4. Make sure the integral circulator pump is operational.
5. Check for proper condensate drainage, cleaning out any dirt and debris. Condensate should flow by gravity to a condensate receiver.
6. Check to see if the packing gland around the valve stem is too tight or the valve stem is bent (*See Technical Data sheets enclosed*).
7. Check for dirt under the valve seat and/or damage to the seat (*See Technical Data sheets enclosed*).
8. The temperature bulb's sensing element may be dysfunctional (*See Technical Data sheets enclosed*).
9. Check to insure there is proper ventilation around the unit. If the unit is not properly ventilated, the unit and control valve may overheat and possibly damage the equipment.

### 2. Banging or pinging:

1. Check for proper condensate drainage. Clean out all dirt and debris.
2. Check for backpressure in the condensate line. Condensate should flow by gravity to a condensate receiver.
3. Do not attempt to lift condensate above the orifice union height.
4. Check that any customer installed auxiliary steam trap(s) are operating properly.



Figure 3

# Trouble Shooting

---

## 3. Erratic temperature control:

1. Verify an electrical signal from the temperature sensor to the controller. Verify the electrical signal from the controller to the control valve. Check the setting of the SV to verify it is at the desired temperature. If this is not the case the SV may need adjustment.
2. Make sure the integral circulator pump is operational.
3. Check for proper flow direction of the circulator pump. The pump should be flowing downwards to the cold domestic inlet nozzle.
4. Check for backpressure in the condensate line. Condensate should flow by gravity to a condensate receiver.
5. Confirm steam supply pressure to the valve is steady and agrees with that specified in the List of Materials. *(See List of Materials enclosed).*
6. Check steam orifice union for proper operation, cleaning if necessary.
7. Check that any customer installed auxiliary steam trap(s) are operating properly.
8. Check the control temperature bulb for exterior scale or buildup and clean if necessary.
9. Check for and clean out, any debris in the upstream strainer, valve body, and valve seat.
10. Sticking valve stem. This can be caused by a bent valve stem or a valve stem not properly lubricated. A sticking valve stem can also be caused by the packing gland assembly being too tight. Loosen the packing gland assembly and lubricate.

## 4. Poor recovery:

1. Check the setting of the SV and verify it is at the desired set point. If this is not the case the SV needs to be adjusted accordingly. The temperature sensor should be checked to see if it is damaged or corroded.
2. Confirm steam supply pressure to the control valve meets that specified in the List of Materials. Check for a clogged strainer, a partially closed supply valve or other obstructions.
3. Make sure the Mini-Pack is not trying to supply more hot water than it was designed for *(See performance listed in List of Materials enclosed).*
4. Check the union orifice plate and auxiliary steam trap(s) for any foreign matter and functionality.
5. Shut unit down, remove bonnet and coil. Inspect for scale and fouling, which restricts proper heat transfer. Clean with an approved chemical treatment as necessary.

## 5. Control Valve not closing:

1. Verify an electrical signal from the temperature sensor to the controller. Verify the electrical signal from the controller to the control valve. Check the setting of the SV to verify it is at the desired temperature. If this is not the case the SV may need adjustment.
2. The packing gland assembly is too tight, locking the valve stem (See Technical literature enclosed).
3. The temperature stem nut assembly is raised too high *(See Technical literature enclosed).*
4. Check for proper operation of the control valve solenoid. The solenoid should be energized and open when the system in normal operating conditions. When the system is off or an over-temp condition occurs, the solenoid should be de-energized and venting air out of its third port.
5. Check for and clean out, any debris in the upstream strainer, valve body, and valve seat. The valve seat may be worn or damaged and unable to seal properly *(See Technical literature enclosed).*



# Error Messages

## Diagnostic Error Messages on the controller

Display		Description	Action Required
PV	B150	Display on Start Up	No Action Required
SV	rr		
PV	No	No Input Probe Connection	Verify that sensor is wired to proper terminals. Next check that the controller is programmed for the correct input type. Most commonly seen when controller is programmed for RTD, while a thermocouple is connected.
SV	Cont		
PV	Err	Input Error	Verify that the input is wired to the proper terminals. Next, check to see if the Input type os set to the proper value. Most commonly seen when controller is programmed for the 4 to 20 mA Input and 0 to 20 mA signal is wired to the controller.
PV	2001	Process Value Flashes when outside of range	Input signals may normally go above or below range limits. If not check input and correct the process temperature range limit using tP-H and tP-L.
SV	0.0		
PV	Err	Error EEPROM	Attempt to reset the factory default setting using the instruction in the Programming Instruction. If still has error, call customer service for a return goods authorization number to have the controller evaluated at the factory.
SV	Pron		

## Maintenance Instruction

**KEEP TUBES CLEAN:** In order to maintain high efficiency, the Mini-Pack tubes should be cleaned periodically. The frequency of cleaning the tubes depends on the characteristics of the water and the type of installation. Contact your local water treatment company for evaluation and recommendations.

**GASKETS:** Tighten gaskets during start up and periodically thereafter. Leaky gaskets can cause corrosion of the stud bolts. It is good practice to use a new gasket each time the tube bundle or bonnet is removed.

**STUDS:** Keep studs protected from corrosion with paint or oil. Keep stud bolts tight to prevent leaky gaskets. Stud bolts will not corrode if they are kept dry and protected. Use caution in removing and reinstalling the bonnet. The Mini-Pack must be shut down and drained before attempting removal. Before removing the nuts, apply penetrating oil and allow it to set for a few minutes. Forcing the nut off could cause breakage. Use a torch to heat the nut and it will come off easier. If a torch is not available, take a cold chisel and place it across the flat of the nut and strike several sharp blows with a heavy hammer. This should loosen the nut. If necessary, it is better to split the nut open and replace it than to break the stud off.

**CONTROLS:** Under normal conditions, controls furnished with the Mini-Pack require very little service. It is important, however, that the controls be protected from moisture. All controls should be checked frequently to make sure that they are working properly.

# Maintenance Instruction

---

**CONTROLS:** Under normal conditions, controls furnished with the Mini-Pack require very little service. It is important, however, that the controls be protected from moisture. All controls should be checked frequently to make sure that they are working properly.

**RELIEF VALVE:** The Mini-Pack is equipped with a lever type relief valve of “ASME” rated capacity. To maintain the valve in good working condition, it should be manually opened once a month. The relief valve outlet should be piped directly to an open drain and the drain checked frequently for discharge. If the relief valve is leaking or does not operate freely it should be replaced.

**HIGH LIMIT AQUASTAT:** The Mini-Pack is equipped with a high limit temperature safety aquastat designed to shut down the unit in the event the water temperature exceeds the high limit set point. The high limit should be set 12°F to 15°F above the desired domestic hot water outlet temperature set point. For example, if the system is heating domestic water from 40°F to 140°F, the high limit should be set at ~152°F. The high limit aquastat will automatically reset when the temperature drops the set differential number of degrees. The adjustable differential should be set so that the system does not start up again until the water temperature drops at least 5 degrees below the desired hot water outlet temperature (typically 135°F on a 140°F system). Continuing the example, with the high limit set at 152°F, the differential should be set at least 17, thus ensuring that the system does not start heating until the water temperature drops 17°F down to 135°F. Refer to the included manufacturer’s data sheet for adjustment information. Turn the high limit safety control up and down to verify proper operation.

## Removing The Tube Bundle

*Caution: It is recommended that you wear gloves and eye protection.*

1. Shut down the unit as described in the shut down instructions.
2. After the Mini-Pack has cooled, isolate the Mini-Pack by closing off the manual valves at the domestic water inlet and outlet locations. Drain the water remaining in the shell to a safe sewer drain.
3. Disconnect the steam inlet line and condensate outlet line from the tube bundle bonnet.
4. Remove the nuts from the bonnet side first in order to remove the bonnet. Care must be taken when lowering the bonnet.
5. The tube bundle can now be removed by removing the nuts holding it to the shell.
6. Caution: The tube bundle is very heavy. Care should be taken when removing it from the shell. Approximate tube bundle, bonnet, and shell weights without base are as listed.

# Maintenance Instruction

## Mini-Pack Component Weights

### Single-Wall Units

MP Size	Coil Weight	Bonnet Weight	Shell Weight
4"	30 lbs.	30 lbs.	60 lbs.
5"	54 lbs.	40 lbs.	73 lbs.
6"	77 lbs.	45 lbs.	85 lbs.
8"	110 lbs.	60 lbs.	115 lbs.
8L"	132 lbs.	60 lbs.	125 lbs.
10"	200 lbs.	95 lbs.	180 lbs.
10L"	230 lbs.	95 lbs.	200 lbs.
12"	253 lbs.	130 lbs.	250 lbs.
12L"	300 lbs.	130 lbs.	300 lbs.

### Double-Wall Units

MP Size	Coil Weight	Bonnet Weight	Shell Weight
5"	125 lbs.	40 lbs.	95 lbs.
6"	170 lbs.	45 lbs.	105 lbs.
8"	260 lbs.	60 lbs.	135 lbs.
10"	430 lbs.	95 lbs.	210 lbs.
12"	550 lbs.	130 lbs.	310 lbs.

## Gasket Installation

**Caution: It is recommended that you wear proper eye protection.**

1. Thoroughly clean the gasket surface of foreign matter and scratches. Dirt and scale provide leakage paths.
2. Lubricate the bolts and the underside of the nuts. A heavy graphite and oil mixture will do. Threads should be well formed and free running. Lubricating the threads doubles the clamping force.
3. Gasket should be properly positioned before attempting to retighten bolts. The placement of the gasket is important and must be done on a clean surface area. It covers a very thin area, which widens as the bolts are tightened. Place the gasket on the flange toward the outside of the gasket sealing area so that a width of the flange is approximately equal to half the width of gasket is on the outside (as shown in VIEW "A", D equals width of gasket). Peel back adhesive strip protective paper and firmly press down gasket as you go around flange. The adhesive strip will hold the gasket in position. Flanges, especially blind flanges, bend appreciably when bolts are torqued and might come together without adequately compressing the gasket if it were placed further toward the inside of the flange face.

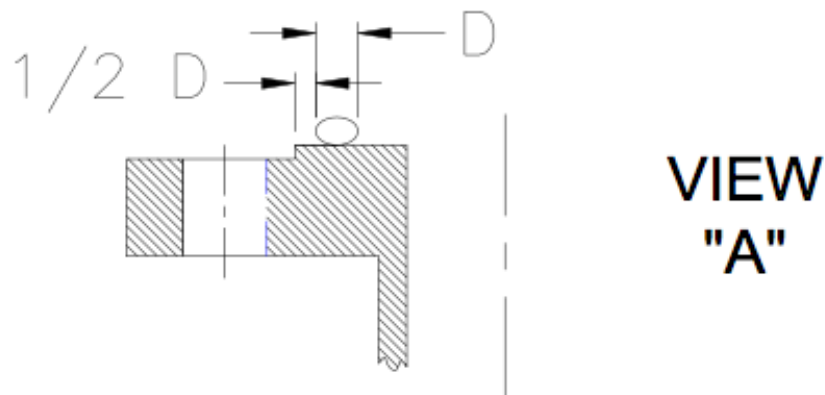

# Maintenance Instruction

---

4. Complete the seal by crossing the ends near a bolt hole. Cross one end over the other about 1" and cut (as shown in VIEW "B").

**VIEW  
"B"**

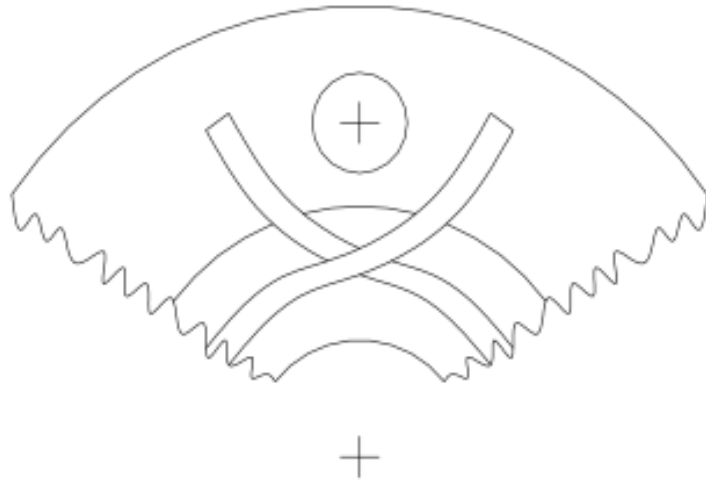

5. Assemble the flanged joints and torque the bolts as follows.
- Run up all the nuts, finger tight.
  - Develop the required bolt stress in a minimum of about three equal steps, following a tightening sequence (as shown in VIEW "C"). The gasket material is highly compressible, but has little resilience; so gradual tightening is necessary to form a gasket of uniform thickness. Use a torque wrench to get recommended torque rating on Page 8.

**VIEW  
"C"**

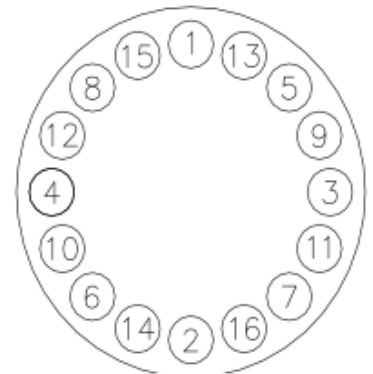
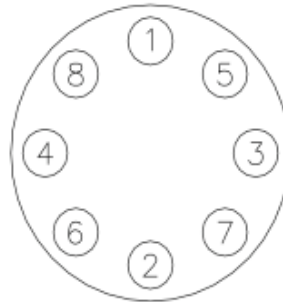
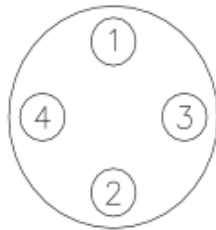

# Maintenance Instruction

---

## Tube Bundle and Bonnet Installation

*Caution: It is recommended that you wear proper eye protection.*

1. Flange and tube sheet preparation: Thoroughly clean the gasket surface of foreign matter and scratches. Dirt and scale provide leakage paths.
2. Apply gaskets: Install gasket material on stationary flange with adhesive side down. See Step #3 from Gasket Installation above on Page 18.
  - a) Overlap material at top of flange.
  - b) Overlapped ends should protrude out of flange, with one end on each side of top bolt.
  - c) Make sure gasket does not extend into bore.

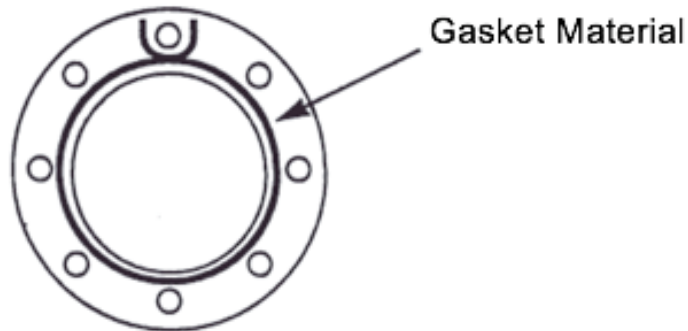

3. Install heat exchanger bundle: Bundle should be lifted or jacked with care as to not damage the tubes or tube sheet gasket surface. Lift the bundle to the proper height prior to tightening nuts down. Do not use the nuts to lift the bundle into the shell. Bundle should be left supported until installation is complete.
4. Apply gasket material on channel bonnet: Overlap gasket material around bolt hole as above. Apply gasket on divider sections as well. Overlap the divider gasket strips over the main gasket.

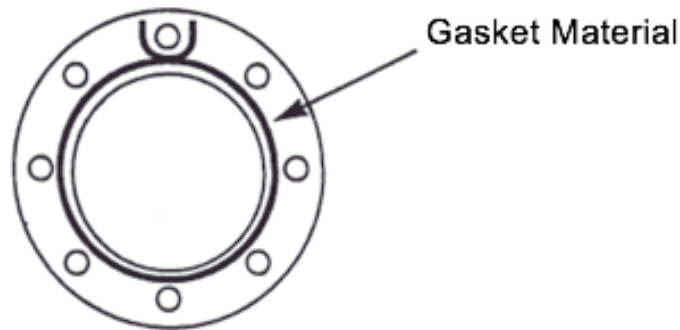

5. Bolting bonnet: Use jack or overhead support to lift bonnet into position, align with the bolts that are in place, level and slide the bonnet against tube sheet. Install nuts on bolts in place and tighten finger tight. The bonnet should be left supported until installation is complete.

# Maintenance Instruction

## Tube Bundle and Bonnet Installation

*Caution: It is recommended that you wear proper eye protection.*

- Torque: Unless otherwise specified, when using Goretex or spiral wound gaskets, use the following table to find recommended bolt tightening torque.

MP Size	Bolt Weight	Minimum Torque	Maximum Torque
4"	1/2"	45 ft. lb	60 ft. lb
5"	1/2"	45 ft. lb.	60 ft. lb
6"	1/2"	45 ft. lb.	60 ft. lb
8"	1/2"	45 ft. lb.	60 ft. lb
10"	5/8"	90 ft. lb.	120 ft. lb
12"	5/8"	90 ft. lb.	120 ft. lb
16"	5/8"	90 ft. lb.	120 ft. lb

- Torque bolts: Set torque wrench to half of recommended torque rating. Tighten bolts according to alternating crossover pattern. Do not over tighten any one bolt initially as this could crimp the gasket. The sequence is to lightly tighten the first bolt then move directly across the circle for the second bolt. Continue as illustrated below. Tighten each bolt in increments repeating the cycle until half torque ratings are reached. Reset torque wrench to full torque rating, and repeat tightening sequence in increments until full torque ratings are reached. Remember, for the gaskets to work properly, the flange faces must be kept parallel and the bolts tightened uniformly.

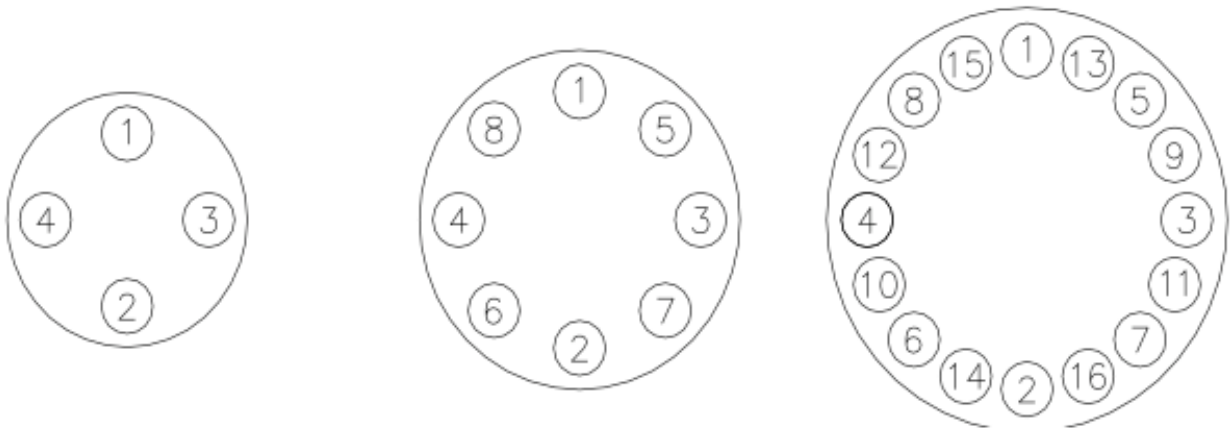

- Completion: When bolt-tightening sequence is complete, remove the support from the tube sheet and the channel bonnet.

# Preventive Maintenance

---

## Every 3 Months:

1. Visually check for leaks at any joints, including the valve body, piping, and controls.
2. Visually check for corrosion on the control valve, Accritem, bulb, and strainer.
3. Check for full valve shut-off. *Refer to Trouble Shooting section on Page 18.*
4. Check for full valve travel. Less than full valve travel may indicate a leak in the diaphragm or bulb, or a plugged air line.
5. Test the Accritem control knob for freedom of movement. Lubricate if necessary.
6. Remove the Accritem from the Mini-Pack and check the temperature control bulb for any corrosion or erosion. Remove/clean any scale from bulb surface.
7. Strainers should be inspected and cleaned. Damaged screens should be replaced with same mesh.
8. Check and tighten flange nuts as needed.

## Annual Maintenance:

1. The relief valve must be tripped to insure proper operation as a safety device.
2. Pull the tube bundle and clean the inside and outside of the tube bundle of scale. The frequency of tube cleaning will be determined after inspection. (Heavy scale will indicate that more frequent cleaning is necessary). A light sludge or scale coating on the tube greatly reduces its effectiveness. A marked increase in pressure drop and/or reduction in performance usually indicate cleaning is necessary. The tube bundle should be cleaned with a tube brush and/or an acceptable cleaning solution.
3. Check ALL operating components for proper functionality. Check all electrical connections.

## Replacement Parts

Ace Heaters maintains a complete equipment list for each Mini-Pack, filed by serial number. In order for us to give prompt service and to ensure that correct parts are supplied, please be sure and supply the model and serial number.

Replacement parts may be ordered from directly from manufacturer.

## Material Data Safety Sheets

Some of Ace products contain materials that have been recognized as posing health risks. Material Safety Data Sheets for these materials are available from your local Manufacturer's rep. When requesting this information, be sure to have the model number and serial number available.

If you do not know who your local Manufacturer's Rep is, you can find out by logging into the [aceheaters.com](http://aceheaters.com) website, and clicking on the Representative tab found in the table of contents.

## ACE Mini-Pack/SWH BMS Panel (Water/Steam)



### Operating Keys



**INDEX:** Pressing the **INDEX** key advances the display to the next menu item.



**UP ARROW:** Increments a value or changes a menu item.

- If pressed during the **Operation Mode**, the Setpoint value will be increased.



**DOWN ARROW:** Decrements a value or changes a menu item.

- If pressed during the **Operation Mode**, the Setpoint value will be decreased.



**ENTER:** Stores the value or item change. If not pressed, the previously stored value or item will be retained.

- When pressed during the **Operation Mode**, the controller switches to the **Regulation Mode**.
- If held for more than 3 seconds during the **Operation Mode**, the controller switches to the **Initial Setting Mode**.
- If pressed during the **Regulation Mode** or **Initial Setting Mode**, the controller will return to the **Operation Mode**.

**This instruction should be used with**

**ACE Mini-Pack/SWH BMS Panel (Water)**

LOVE Controller Model **4C-5** (AHS LLC P/N: **CA4C-5**)

M:\Engineering\4-Controls\4-Programming Instruction\ 2-ACE BMS Panel - Love.doc

Effective Date: 11/7/14







## Home Display

The **Home Display** is the normal display while the control is operating.

**Home Display** will indicate the Temperature (**PV**) that is being measured on the top display and the SetPoint (**SV**) on the bottom display





## Entering Initial Setting Mode

- 1) When the power is applied to the unit, display will show (**Home Display**) temperature on the PV screen. If not check wiring.
- 2) Hold the  key for 3 seconds from the **Home Display** to get to the **Initial Setting Mode**.
- 3) Press the  key to go through the different parameters, and the  and  keys to change parameters and  to save the change.





## Programming in Initial Setting Mode

- 4) In **Initial Setting Mode**, change the following parameters below.

Upper Display	Lower Display	Description
inPt	Pt3	Input Selection
tPUn	F	Temperature Unit
tP-H	212	Scale High Limit
tP-L	32	Scale Low Limit
Ctrl	PID	Control Mode
S-HC	HEAt	Heat/Cool Selection
ALA1	11	Alarm 1 Setting
ALA2	3	Alarm 2 Setting
C-SL	rtU	Communication Protocol
CoSH	on	Communication Write Function
C-no	1	Controller Address
bPS	38Y4	Baud Rate Setting
Len	8	Communication Data Length
PrtY	none	Communication Parity Bit
StoP	1	Communication Stop Bit

- 5) When **inPt** is shown on the upper display, press the  key to review the programmed parameters for the second time to check all parameters are set correctly.
- 6) Press the  key to get back to the Home Display.
- 7) Use  and  key to change the **SV** (setpoint value) to within  $\pm 2$  F off the **PV** value. Press the  key to save the new setpoint value.

### Entering Regulation Mode

- 8) Press the  key from the **Home Display** to get to the **Regulation Mode**.
- 9) Press the  key to go through the different parameters, and the  and  keys to change parameters and  to save the change.





### Programming in Regulation Mode

- 10) In **Regulation Mode**, change the following parameters below.

Upper Display	Lower Display	Description
At	oFF	Auto Tune
P	40	Proportional Band (Units of C)
I	60	Integral Time (S)
d	15	Derivative Time (S)
ioF	0	Integral Deviation Offset
tPoF	0	Process Temperature Offset
CrHi	0	Analog Output High Limit
CrLo	0	Analog Output Low Limit

- 1) Press the  key to get back to the Home Display.

### Entering Operation Mode

- 11) Press the  key from the **Home Display** to get to the **Operation Mode**.
- 12) Press the  key to go through the different parameters, and the  and  keys to change parameters and  to save the change.

### Programming in Operation Mode

- 13) In **Operation Mode**, change the following parameters below.

Upper Display	Lower Display	Description
r-S	rUn	Select Run – Stop Output Control
AL1H	20	High Deviation Alarm On (F)
AL1L	15	High Deviation Alarm Off (F)
AL2L	20	Low Deviation Alarm Off (F)
LoC	oFF	Panel Security Lock
oUT1		Analog Output (%)

- 2) Press the  key to get back to the Home Display.







### Testing Operating Control

- 3) Change the **SV** (setpoint value) so that it is 20° below the **PV** (measured temperature). High Temperature Alarm will activate (dump valve if included) and light will come on.
- 4) Check to see that valve closes fully.
- 5) Deactivate High Temperature Alarm by raising the setpoint value to 5° above the **PV** (measured temperature).

### Change Setpoint



- 6) Change the **SV** (setpoint value) 120 F.

### Enable Key Lock

- 7) Press the  key from the **Home Display** to get to the **Operation Mode**.
- 8) Press the  key until upper display shows **LoC**.
- 9) Press the  and  keys to change parameter to **LoC2** and  to save the change.
- 10) Fill out the **Safety System Test Check Sheet**.
- 11) To unlock press  and  simultaneously.

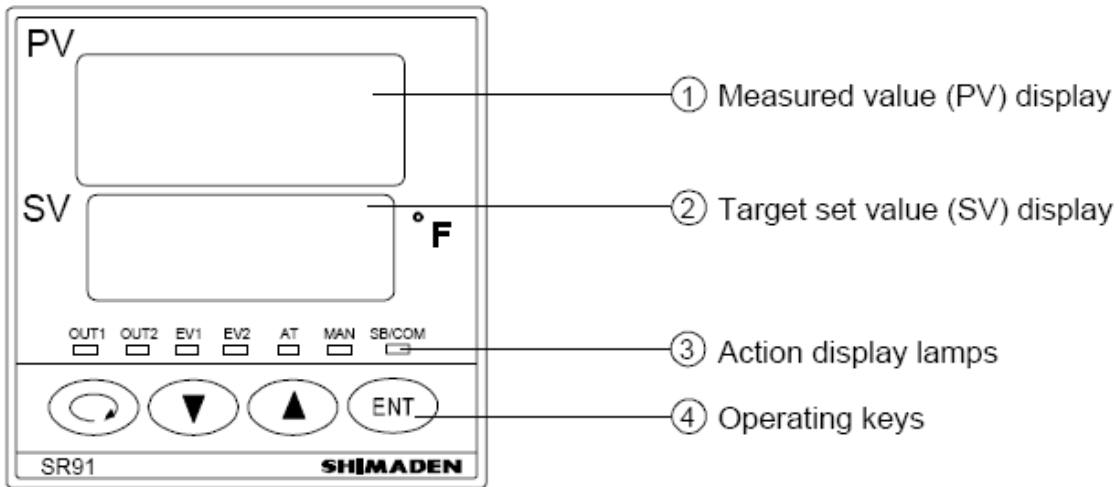
**ACE Mini-Pack/SWH BMS Panel (Water)**  
**ACE USB BMS Panel (Steam)**



-  **Parameter key:** Used to get to the next parameter or different modes.  
Hold to scroll to the first screen.
-  **Arrow keys:** Used to change parameters.
-  **Enter key:** Used to set the parameter after it has been changed.





**This instruction should be used with**

**ACE Mini-Pack/SWH BMS Panel (Water)**  
SHIMADEN Controller Model **SR93-8I-N-90-1050** (AJAX P/N: **CASR931050**)

Or

**ACE USB BMS Panel (Steam)**  
SHIMADEN Controller Model **SR93-4I-N-90-1050** (AJAX P/N: **CASR931050A**)

### Entering Setup Mode





- 1) When the power is applied to the unit, display will show temperature or pressure on the PV screen. If not check wiring.
- 2) Hold the  key for **3** seconds to get to the **Setup Mode**.
- 3) Press the  key to go through the different parameters, and the  and  keys to change parameters and  to save the change.

### Programming in Setup Mode









- 4) In **Setup Mode**, change the following parameters below.  
 \*Start programming from **rAnG** parameter  
 \*\* Indicates Steam Controller parameters

Upper Display	Lower Display	Description
PArA	Set	Setup Mode initial screen
LoCK	oFF	Key lock setting
P	10 (Steam)	Output proportional band setting
I	20 (Steam)	Output integral time
D	5 (Steam)	Output derivative time
ñr	0.0	Output manual reset
SF	0.40	Output target value function
o_L	0.0	Output lower limit **Amuract Wiring Rev.D (Before 3/30/11) – 18.0
o_H	100.00	Output high limit
StEV	oFF	Event at Standby
E1_ñ	Hd	High deviation alarm
E1_d	5.0 (Water) **3.0 (Steam)	High alarm differential
E1_i	1	High alarm event standby action
E2_ñ	Ld	Low deviation alarm
E2_d	0.1	Low alarm differential
E2_i	1	Low alarm event standby action
coññ	Loc	Communication mode
Prot	rtu	Communication protocol
Addr	1	Communication address
dAtA	8n1	Communication data format
SchA	Stx	Start character
bcc	1	BCC operation type
bPS	9600	Communication speed
dELY	20	Communication delay time
ñEñ	EEP	Communication memory mode
Act	rA	Reverse acting control
SoFt	oFF	Soft start time







SV_L	40.0 (Water) **0.0 (Steam)	Setpoint lower limit
SV_H	180.0 (Water) **Vessel – 8 (Steam)	Setpoint high limit
PV_b	0	Outlet temperature/pressure bias value
PV_F	0	Outlet temperature/pressure filter time
* rAnG	<b>34 (Water)</b> <b>**92 (Steam)</b>	<b>Sensor and measuring range</b> <b>* Start Here*</b>
Unit	F (Water Only)	Temperature unit
Sc_L	0.0	Input scale lower limit
Sc_H	400.0 (Water) **150.0 (Steam)	Input scale high limit
Scdp	0.0	Input decimal point position
Disp	Pb	Temperature/pressure display at standby

- 5) When **PARA** shown, press the  key to review the programmed parameters for the second time to check all parameters are set correctly.
- 6) Scroll until **PARA** shown on the display again, hold down the  key for 3 seconds to get to **Operation Mode**.
- 7) Use  and  key to change the **SV** (setpoint value) to within  $\pm 2$  F/PSI off the **PV** value. Press the  key to save the new setpoint value.

#### **Programming High and Low Deviation Alarm**

- 8) Press the  until **E1Hd** is shown. Using the  and  key to change the value to **20** (for water) or **6** (for steam) and press the  key to save the new High Deviation alarm value.
- 9) Press the  until **E2Ld** is shown. Using the  and  key to change the value to **-10** and press the  key to save the new Low Deviation alarm value.  
**Note:** The High Temperature/Pressure Alarm is activated when **PV** is **E1Hd** above **SP** and Low Temperature/Pressure Alarm is activated when **PV** is **IE2LdI** below **SP**.
- 10) Hold the  key for 3 seconds to display **PV** (measured temperature/pressure) and **SV** (setpoint value).

#### **Testing Manual Valve Control**

- 11) Press the  key once to get to valve position screen.
- 12) Hold down the  key until the **MAN** light starts to flash.
- 13) Change the parameter to **99.9** using the  and  key. Check to see that valve opens fully. (Valve should be at 90°)
- 14) Change the parameter to **50** using the  and  key. Check to see that valve opens to half way. (Valve should be at 45°)
- 15) Hold down  key until **MAN** light stops flashing.

#### **Testing Operating Control (Water Only)**

- 16) Change the **SV** (setpoint value) so that it is 20° below the **PV** (measured temperature). High Temperature Alarm will activate (dump valve if included) and light will come on.
- 17) Check to see that valve closes fully.

- 18) Deactivate High Temperature Alarm by raising the setpoint value to 5° above the **PV** (measured temperature).







**Testing Operating Control (Steam Only)**

- 19) Remove Pressure Transducer and apply 15 PSI pressure.  
20) Change the **SV** (setpoint value) so that it is 7 PSI below the **PV** (measured Pressure).  
High Pressure Alarm will activate and light will come on.  
21) Check to see that valve closes fully.  
22) Deactivate High Pressure Alarm by raising the setpoint value to 5 PSI above the **PV** (measured pressure)

**Change Setpoint**



- 23) Change the **SV** (setpoint value) 120 F for Water and 10 PSI for Steam.

**Enable Key Lock**

- 24) Hold down  key until you get see the Setpoint and Process Variable.  
25) Hold down the  key for 3 seconds to get to the **Setup Mode**.  
26) Press the  key until you see **LoCK** on the PV screen.  
27) Change this parameter to **2** and press the  key to save the new parameter.  
28) Hold down the  key until you PV display shows **PArA**.  
29) Hold down the  key for **3** seconds to get back to the **Operation Mode**.  
30) Fill out the **Safety System Test Check Sheet**.

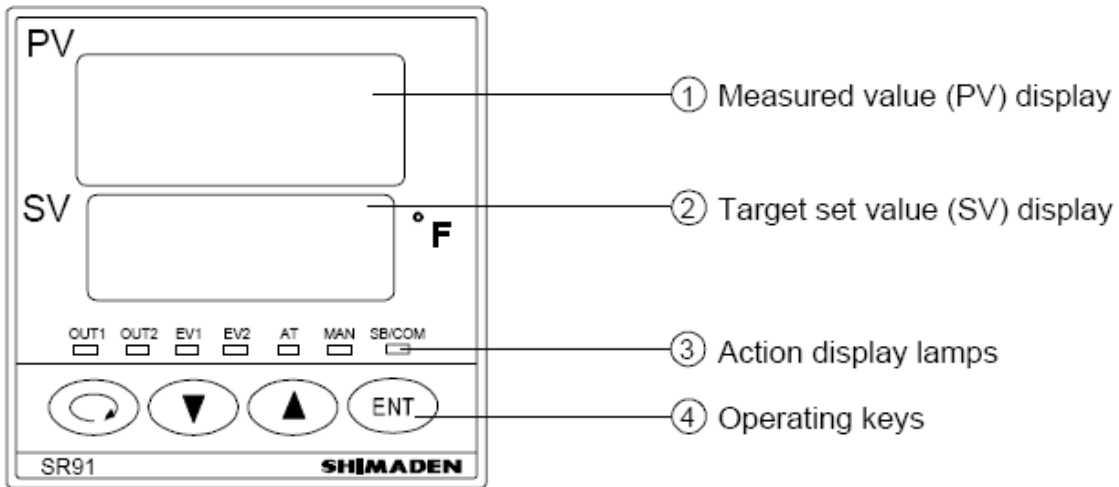
**ACE Mini-Pack/SWH Digital Panel (Water)**  
**ACE USB Digital Panel (Steam)**



-  **Parameter key:** Used to get to the next parameter or different modes.  
Hold to scroll to the first screen.
-  **Arrow keys:** Used to change parameters.
-  **Enter key:** Used to set the parameter after it has been changed.

**This instruction should be used with**





**ACE Mini-Pack/SWH Digital Panel (Water)**  
SHIMADEN Controller Model **SR93-8I-N-90-1400** (AJAX P/N: **CASR931400**)

Or

**ACE USB Digital Panel (Steam)**  
SHIMADEN Controller Model **SR93-4I-N-90-1400** (AJAX P/N: **CASR96140**)



### Entering Setup Mode





- 1) When the power is applied to the unit, display will show temperature or pressure on the PV screen. If not check wiring.
- 2) Hold the  key for **3** seconds to get to the **Setup Mode**.
- 3) Press the  key to go through the different parameters, and the  and  keys to change parameters and  to save the change.

### Programming in Setup Mode









- 4) In **Setup Mode**, change the following parameters below.  
 \*Start programming from **rAnG** parameter  
 \*\* Indicates Steam Controller parameters

Upper Display	Lower Display	Description
PArA	Set	Setup Mode initial screen
LoCK	oFF	Key lock setting
P	10 (Steam)	Output proportional band setting
I	20 (Steam)	Output integral time
D	5 (Steam)	Output derivative time
ñr	0.0	Output manual reset
SF	0.40	Output target value function
o_L	0.0	Output lower limit **Amuract Wiring Rev.D (Before 3/30/11) – 18.0
o_H	100.00	Output high limit
StEV	oFF	Event at Standby
E1_ñ	Hd	High deviation alarm
E1_d	5.0 (Water) **3.0 (Steam)	High alarm differential
E1_i	1	High alarm event standby action
E2_ñ	Ld	Low deviation alarm
E2_d	0.1	Low alarm differential
E2_i	1	Low alarm event standby action
Ao_ñ	PV	Analog Output Type
Ao_L	40.0 (Water) **0.0 (Steam)	Analog Output Low Limit
Ao_H	200.0 (Water) **150.0 (Steam)	Analog Output High Limit
Act	rA	Reverse acting control
SoFt	oFF	Soft start time
SV_L	40.0 (Water) **0.0 (Steam)	Setpoint lower limit
SV_H	180.0 (Water) **Vessel – 8 (Steam)	Setpoint high limit
PV_b	0	Outlet temperature/pressure bias value







PV_F	0	Outlet temperature/pressure filter time
* rAnG	<b>34 (Water)</b> <b>**92 (Steam)</b>	<b>Sensor and measuring range</b> <b>* Start Here*</b>
Unit	F (Water Only)	Temperature unit
Sc_L	0.0	Input scale lower limit
Sc_H	400.0 (Water) <b>**150.0 (Steam)</b>	Input scale high limit
Scdp	0.0	Input decimal point position
Disp	Pb	Temperature/pressure display at standby

- 5) When **PArA** shown, press the  key to review the programmed parameters for the second time to check all parameters are set correctly.
- 6) Scroll until **PArA** shown on the display again, hold down the  key for 3 seconds to get to **Operation Mode**.
- 7) Use  and  key to change the **SV** (setpoint value) to within  $\pm 2$  F/PSI off the **PV** value. Press the  key to save the new setpoint value.

#### **Programming High and Low Deviation Alarm**

- 8) Press the  until **E1Hd** is shown. Using the  and  key to change the value to **20** (for water) or **6** (for steam) and press the  key to save the new High Deviation alarm value.
- 9) Press the  until **E2Ld** is shown. Using the  and  key to change the value to **-10** and press the  key to save the new Low Deviation alarm value.  
**Note:** The High Temperature/Pressure Alarm is activated when **PV** is **E1Hd** above **SP** and Low Temperature/Pressure Alarm is activated when **PV** is **IE2LdI** below **SP**.
- 10) Hold the  key for 3 seconds to display **PV** (measured temperature/pressure) and **SV** (setpoint value).

#### **Testing Manual Valve Control**

- 11) Press the  key once to get to valve position screen.
- 12) Hold down the  key until the **MAN** light starts to flash.
- 13) Change the parameter to **99.9** using the  and  key. Check to see that valve opens fully. (Valve should be at 90°)
- 14) Change the parameter to **50** using the  and  key. Check to see that valve opens to half way. (Valve should be at 45°)
- 15) Hold down  key until **MAN** light stops flashing.

#### **Testing Operating Control (Water Only)**

- 16) Change the **SV** (setpoint value) so that it is 20° below the **PV** (measured temperature). High Temperature Alarm will activate (dump valve if included) and light will come on.
- 17) Check to see that valve closes fully.
- 18) Deactivate High Temperature Alarm by raising the setpoint value to 10° above the **PV** (measured temperature).







### **Testing Operating Control (Steam Only)**

- 19) Remove Pressure Transducer and apply 15 PSI pressure.
- 20) Change the **SV** (setpoint value) so that it is 7 PSI below the **PV** (measured Pressure).  
High Pressure Alarm will activate and light will come on.
- 21) Check to see that valve closes fully.
- 22) Deactivate High Pressure Alarm by raising the setpoint value to 5 PSI above the **PV** (measured pressure)

### **Change Setpoint**

- 23) Change the **SV** (setpoint value) 120 F for Water and 10 PSI for Steam.

### **Enable Key Lock**

- 24) Hold down  key until you get see the Setpoint and Process Variable.
- 25) Hold down the  key for 3 seconds to get to the **Setup Mode**.
- 26) Press the  key until you see **LoCK** on the PV screen.
- 27) Change this parameter to **2** and press the  key to save the new parameter.
- 28) Hold down the  key until you PV display shows **PArA**.
- 29) Hold down the  key for **3** seconds to get back to the **Operation Mode**.
- 30) Fill out the **Safety System Test Check Sheet**.



## FACTORY LIMITED WARRANTY POLICY

The Ace Factory limited warranty provides assurance that all products are free from manufactureres defects at the time of shipment and meet specifications and performance described in the product literature.

It is important to understand the difference between a factory warranty and an installed warranty. There are many factors that can occur to the products after they are shipped that the company has no control over and can not fully verify. These includes:

1. Hidden damage during the shipping.
2. Handling damage.
3. Damage during storage.
4. Installation conditions.
5. Other unknown variables in the system design: maintenance, pulsation and vibrations.

The installed warranty is the responsibility of the architech, specifying engineer, contractor and/or owner who jointly have control over the application, installation, location, operating and maintenance conditions.

**The Ace Heaters, LLC warranty excludes extended liabilities. Extended liability typically occurs when products are installed without proper drainage, flooding containment or when safety devices are not tested and repaired or replaced when needed.**

Product problems are often caused by the condition of the water, the lack of water treatment and/or the improper treatment of the water, insufficient combustion air, improper draft conditions, bolts not re-tightened, pipes not flushed and cleaned of oil, metal chips, rags, vibration and pulsation etc. These are installation, operating and/or maintenance conditions that are beyond the seller's responsibility and are not covered by the factory warranty, but may be covered by the installer's warranty.

The factory warranty covering company products is based upon extensive product development and testing. Combustion products under go certification testing and approvals to Underwriters Laboratory (UL) standards. Auditing of the production of combustion products is conducted by a nationally recognized testing laboratory.

Pressure vessel products are designed and manufactured to American Society of Mechanical Engineering (ASME) and National Board (NB) Design standards. Design reviews, factory product manufacturing quality inspections and testing are carried out by a third party National Board authorized inspection agency.

**Ace Heaters, LLC products have proven themselves in service for over 85 years which indicates that the company products perform exceedingly well when normal installation, operating and maintenance conditions exist.**

The following is a review from the terms and conditions of sale. Also included in paragraph two, below, is the Ace Heaters LLC nonconformance policy.

1. Ace Heaters, LLC warrants its products against defective material and/or workmanship only. The warranty does not apply to operational failures, electrical failures, gasket leaks, and/or other malfunctions caused by improper application, installation and/or maintenance.
2. It is the buyer's responsibility to inspect and accept the product, when received, as conforming to their purchase order, specifications and approved drawings. All claims for non-conformance, errors, shortages, etc. must be made within 10 days after receipt of the shipment.
3. Ace Heaters, LLC do not provide a warranty or guarantee, express or implied, in any manner, form, usage of trade, merchantability or fitness which extend beyond the product description and quotation.
4. Ace Heaters, LLC liability is limited to the factory repair or replacement of warranty failures, or non-conformance, upon the return of the product to the factory.
5. Ace Heaters, LLC is not liable for any direct or consequential damages.
6. Ace Heaters, LLC warranty is based upon section 23161(2) of the uniform commercial code and is printed in the term and conditions of sale which is referenced in every quotation, on the back of sales order acknowledgements and invoices. It is legally correct and is an industry standard policy.

s



## Water Heater – Water Quality Requirements

Properly ensuring the water within the water heater is treated is essential for maintaining the water heaters performance over time and preserving the components connected to the system. It is advisable to manage any water treatment program under the guidance of a water treatment specialist.

Water heaters can suffer from scale buildup and chemically induced corrosion due to poor water quality. Among these problems, the most common is the formation of scale inside the unit, which predominantly occurs on the hottest surface; the u-tube bundle heat exchanger. The accumulation of scale in the unit can lead to a reduction in the water heater's capacity as it coats the heat exchanger surface.

Poor water quality can contribute to chemically induced corrosion of the heat exchanger or the vessel. Different forms of chemically induced corrosion may arise, including general corrosion, pitting corrosion, and stress corrosion. Such corrosion has the potential to significantly decrease the lifespan of the vessel or the tube bundle. General corrosion might manifest as a uniform deterioration of the tube, tubesheet, or vessel material, eventually causing material failure. Pitting corrosion involves the creation of small pits on the tubes, tubesheet, or shell, which can ultimately lead to material failure. Stress corrosion results in stress corrosion cracking. This refers to the development of brittle cracks along the metal's stress lines and grain boundaries. Stress corrosion cracking is more likely to affect materials like austenitic stainless steel, such as the grade 316L commonly used in the water heater's vessel, tubes, and tubesheet. This type of corrosion is associated with the presence of chlorides in the water. The likelihood of stress corrosion cracking increases with higher concentrations of chlorides and temperatures.

Under normal design and operating conditions, the water temperatures within a water heater usually remain below the threshold required for stress corrosion to occur.

Ace Heaters, LLC requires all water heaters to be operated within the following ranges to help control corrosion and scaling:

Water Property	Range
Alkalinity (CO <sub>3</sub> , HCO <sub>3</sub> )	Less than 300 ppm
Chlorides	Less than 100 ppm
Conductivity	Less than 1,500 ppm (3,000 uS/cm)
pH	6-8
Silica	Less than 150 ppm
Sulfates	Less than 250 ppm
Total Dissolved Solids	Less than 50 ppm
Total Hardnes (Ca and Mg)	Less than 150 ppm



# WARRANTY

## Limited

Ace Heaters, LLC provides a limited warranty on its products against **defective material and/or workmanship only**. This limited warranty is not applicable to operational failures, electrical failures, gasket leaks, wear or malfunctions caused by improper application, storage, installation, and/or maintenance.

Product Period - The following Limited Warranty period are from date of shipment:

### **Tanks**

**Tanks - Carbon Steel:** One Year

**Tanks - Stainless Steel:** Three Years

**Storage Water Heaters Single-wall or Double-wall Tank/Exchanger Coils:** One Year

**Clean Steam Generators:** One Year

**Linings:** (Pro-rated Warranty)

*Magnesium Anodes must be used at all times to maintain the Limit Warranty*

### **Section VIII Tanks:**

Epoxy: 30" dia. and above (Three years)

Glass: 24" dia. and under (One year).

Glass: 30" dia. and above (Five years).

Cement: (Five years).

Pre-Krete: (Ten years).

### **Section IV Tanks: SW Model Only**

Glass (One year) & Epoxy (Three years).

**Minipacks™ Single-wall or Double-wall:** One Year

**Shell & Tube Heat Exchangers Single-wall or Double-wall:** One Year

**Atlas™ Series Condensing Boiler (Heat Exchanger):** One Year

**Triton™ Series Near Condensing Boiler (Heat Exchanger):** Twelve Years

**Liberty™ Series Condensing Boiler (Heat Exchanger):** Ten Years

**B-Series Copper Fin Boiler:** Three Years

**Controls:** Components manufactured by other than Ace Heaters, LLC such as controls, instruments, forced draft burner, etc., provided with the boilers and packaged products are not covered by the Ace Heaters, LLC Warranty. However, Ace Heaters, LLC extends to the customer the same warranty provided by the manufacturer to Ace Heaters, LLC. The customer shall receive the full benefits of adjustments made to Ace Heaters, LLC by the manufacturer.

Any claim for adjustment under this limited warranty must be made within the warranty period. Ace Heaters, LLC's liability shall be limited to factory repair or, at Ace Heaters, LLC's option, replacement of all parts which, upon test and examination by Ace Heaters, LLC, prove to be defective material and/or workmanship and within the above limited warranty. If required by Ace Heaters, LLC, parts which are claimed to be defective must be promptly delivered to the Ace Heaters, LLC facility, transportation charges prepaid. This warranty does not cover the cost of labor, removal, or installation of the warranted item during the limited period. This warranty is limited to the above and applies only for the period set forth. Ace Heaters, LLC will not be liable for any loss damage, direct, incidental or consequential damages of any kind, whether based upon warranty, contract, negligence or strict liability and arising in connection with the sale, use or repair of the products. Ace heaters's maximum liability shall exceed the contract price for the product's merchantability or fitness for any particular purpose and in no event shall be held responsible for any consequential damages.

For complete Limited Warranty conditions see Section G and H under terms and condition of sale.

Ace Heaters, LLC, also doing business as Ace Heaters, LLC, is referred to herein as Ace Heaters, LLC



**Ace Heater, LLC**

130 Klug Circle, Corona CA 92878

PHONE: (951) 738-2230 • FAX: (951) 281-4959

[www.aceheaters.com](http://www.aceheaters.com)

Ace Heaters, LLC

# WARNING

## PRODUCT SAFETY NOTICE

### ACE BOILER AND WATER HEATER PRODUCTS OPERATE AT HIGH TEMPERATURE AND PRESSURES

- Before using this product, read and understand instructions. Save these instructions for future use.
- Before servicing, to prevent serious burns or injury, the boiler and water heater products must be cooled to less than 80°F (27°C) and the pressure must be 0 psi (0 bar).
- Turn off the electrical power before making electrical connections to prevent electrical shock.
- These products must be placed in a controlled location where untrained or unqualified personnel cannot access the operating or safety controls, must not be able to come in contact with high temperature or high pressure parts and must not perform maintenance or demolition work.
- All work performed must be by qualified properly equipped personnel trained in the proper application, installation, and maintenance or demolition of plumbing, steam, and electrical equipment and/or systems in accordance with all applicable codes and ordinances.
- ACE Boilers and Water Heaters are complete package units with safety and operating controls and are constructed with non ASBESTOS materials. Any replacement gaskets, refractory, insulation, etc used must not contain Asbestos.
- No additional insulation is required on the Boilers and Water Heaters.
- Additions or replacement of insulation on any connecting pipes or accessories to the Boilers and/or Water Heaters must be of "NON-ASBESTOS" and contain only non-hazardous materials.
- Crystalline Silica, a material known to cause cancer, may be encapsulated in some refractory or insulation materials and must be handled only by authorized trained personnel. Crystalline Silica as used is encapsulated and is not harm full in this form. Care must be taken during removal or replacement of refractory or insulation to remove it in bulk form and avoid generation or inhalation of dust. Removal must be properly performed by trained, qualified and equipped personnel. This is also true of Asbestos not contained in ACE products but may be otherwise contained in replacement materials or parts, in connecting piping or other nearby products.
- All safety and operating controls must be set within the specified operating limits and tested periodically to assure proper operation. All limit and operating controls must be installed in series on the boiler.
- Connect drain pipes to a safe drain to prevent serious personal injury from relief valve discharge and or from boiler blow down discharge.
- After installation, check for proper operation of all limit and operating controls before leaving the site.
- Perform scheduled and annual inspections including checking Controls for proper calibration and performance.

**Failure to follow these warnings, to allow access by unauthorized persons and the use of non-properly trained and equipped personnel in the operation, service, modification, removal or demolition of these products or replacement of parts with non-authorized factory non-asbestos materials could cause damage, personal injury or death.**

**Ace Heaters. LLC**  
www.aceheaters.com



Aceheaters.com  
130 Klug Circle  
Corona, CA 92878

(951) 738-2230